

space·pro<sup>o</sup>  
HARDWARE

LINEAR  
Door Hardware





**Produce great looking, versatile & quality sliding doors with Spacepro steel hardware. We have everything you need to make doors you'll be proud to sell.**

The Classic with a twist, the Linear profile boasts slim asymmetric curves. With a wide choice of block colours or wood effect finishes the Linear door can cater for any home with looks that span from the traditional to the modern.

**Key features:**

- Wide range of unicolour and wood effect frame finishes available
- Easy and quick to assemble
- Improved running gear for the smoothest of sliding actions
- Compatible range of installation accessories available to finish the job

**Door suggestions...**

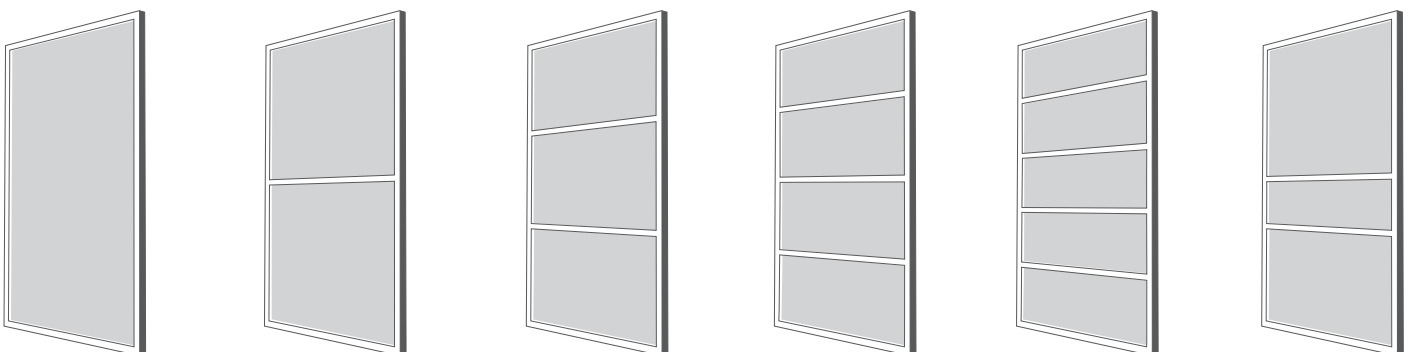

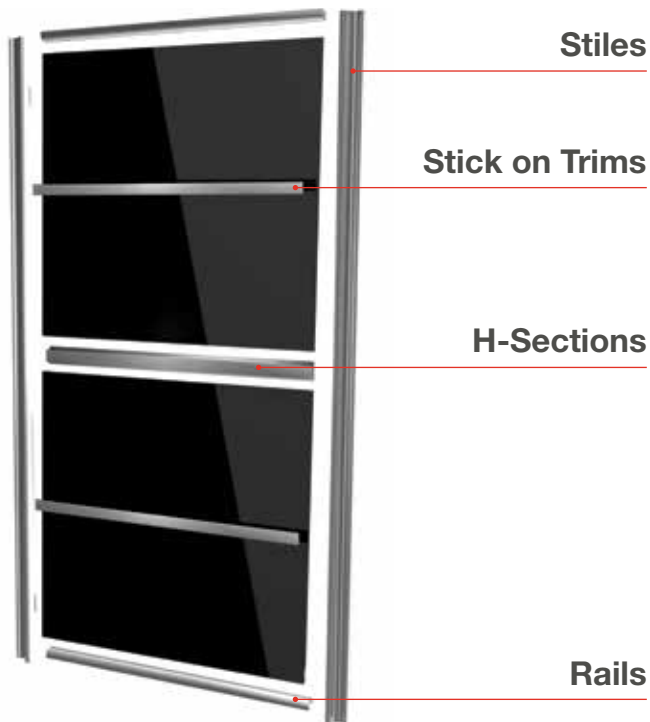

## Door Components

### Stile

4mm 00-6037-2450-XX  
8mm 00-6087-2450-XX

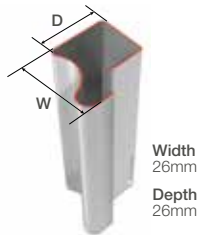

### Rail

4mm 00-4058-2438-XX  
8mm 00-4078-2438-XX

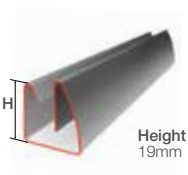

### H-Section

4mm 00-2704-2438-XX  
8mm 00-2708-2438-XX

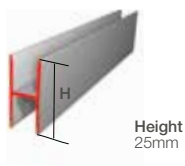

### Running Gear

Top Guide  
00-4020-CH



Top Wheel  
00-5023-CH



Top Wheel  
(For use with soft close)  
00-2848-8-CH



Bottom Wheel  
30kg 00-4264Y-030ZGY-CH  
50kg 00-4264Y-050ZGY-CH



Bottom Wheel  
00-3228-050ZBK



### Tracks

Double Channel  
Top Track  
00-1656-5004-XX

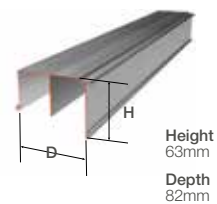

Double Channel  
Bottom Track  
00-2044X-5004-XX

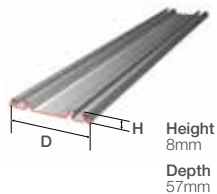

### Soft Close

30kg USC-030  
50kg USC-050



# LINEAR

## Door Installation

Top tracks are also compatible with single sided soft close.

Bottom Guide/Wheel

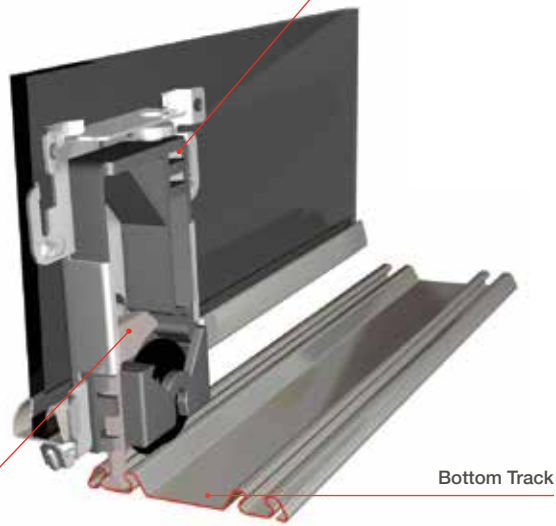

Top Track



## Door Installation Order

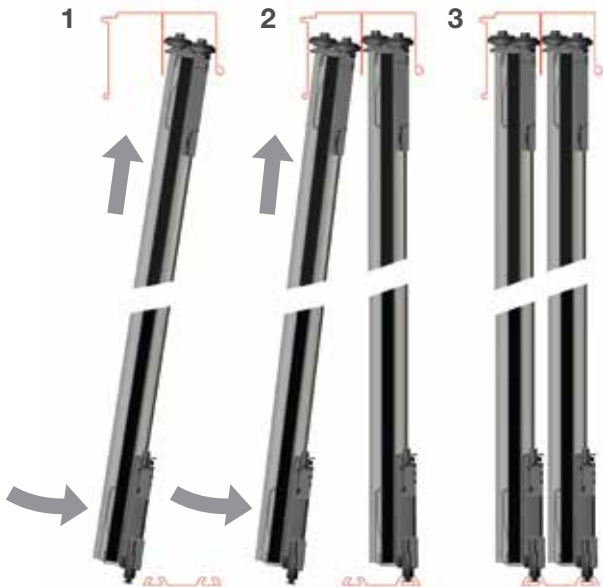

## Technical Information

Calculating doors and overlap widths.

Sliding Door Overlap	26mm
Door Height	Opening height minus 54mm (track & wheel allowance)
Door Width (for sliding doors)	$\frac{\text{Opening width} + (\text{Number of overlaps} \times \text{Overlap length})}{\text{Number of doors}}$
Stile Length	Equivalent to door height
Rails & H-Section Lengths	Finished door width minus 2 x overlap
Panel Height (1 Panel)	Door height minus 2mm
Panel Height (Multi Panel)	Panel height divided by the quantity minus 1mm for each break
Panel Width	Finished door width minus 2mm

Door configurator can be provided on request.

Ask your Spacepro account manager for information about notching tools.

Visit [spaceprohardware.com](https://spaceprohardware.com) for more information

# LINEAR



## Finishes available to Linear Doors

- SC** Silver
- WT** White
- NC** Cashmere
- PB** Black
- WC** Platinum White
- SG** Stone Grey
- OK** Lancaster Oak



space·pro<sup>o</sup>  
HARDWARE

CLEVER STORAGE...  
FOR ANY ROOM,  
IN ANY HOME

LINEAR  
Door Hardware

[spaceprohardware.com](http://spaceprohardware.com)

Home Decor GB Ltd  
Innovation Way, Woodhouse Mill, Sheffield, S13 9AD. UK  
+44 (0) 114 293 3000

HD\_SPH\_04.21