

space.pro^o
HARDWARE

SHAKER

Door Hardware





Produce great looking, versatile & quality sliding doors with Spacepro steel hardware. We have everything you need to make doors you'll be proud to sell.

An undoubted modern classic, the Shaker profile is at home in traditional or contemporary surroundings. Available in a variety of wood finishes or matt white.

Key features:

- 'Shaker' design exclusive to Spacepro
- Wide range of unicolour and wood effect finishes available
- Easy and quick to assemble
- Improved running gear for the smoothest of sliding actions

Door suggestions...

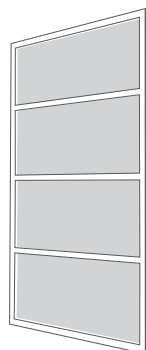
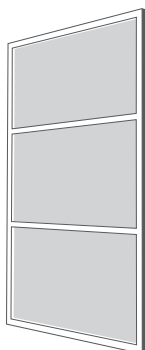
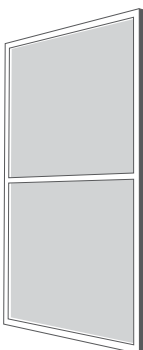

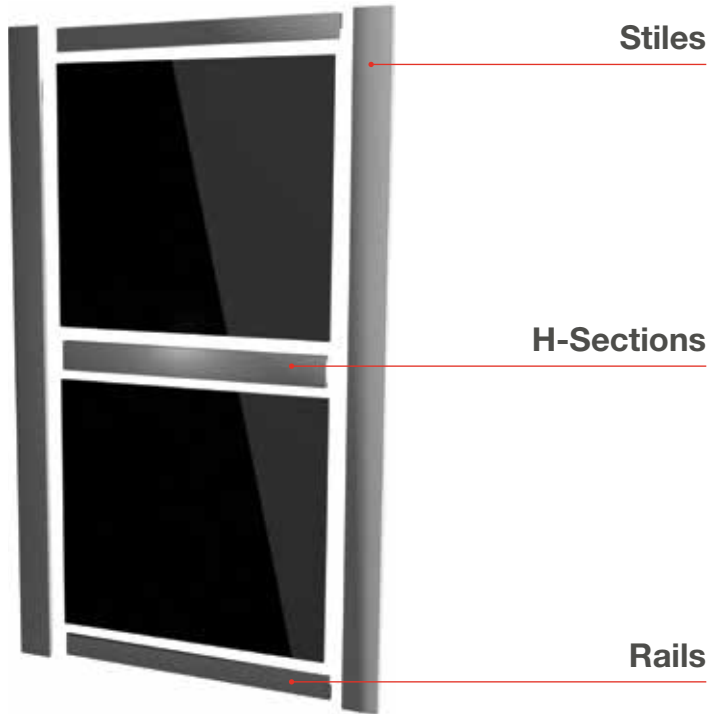

Door Components

Stile

4mm 2700-2450-XX
8mm 2667-2450-XX



Width
75mm
Depth
28mm

Rail

4mm 3504-2438-XX
8mm 3508-2438-XX



Height
55mm

H-Section

3532-2440-XX



Height
75mm

Soft Close

30kg USC-030
50kg USC-050



Running Gear (Wheels/Guides)

Top Guide
00-4020-CH



Top Wheel
00-5023-CH



Top Wheel
(For use with soft close)
00-2848-8-CH



Bottom Wheel
30kg 00-4264Y-030ZGY-CH
50kg 00-4264Y-050ZGY-CH



Bottom Wheel
00-3228-050ZBK



Tracks

Double Channel Top Track
00-1656-5004-XX

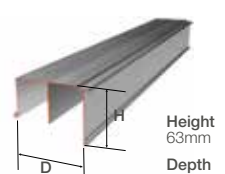

Height
63mm
Depth
82mm

Double Channel Bottom Track
00-2044X-5004-XX

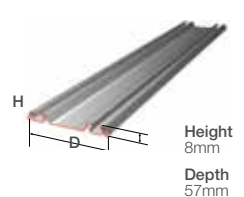

Height
8mm
Depth
57mm

SHAKER

Door Installation

Top tracks are also compatible with single sided soft close.

Bottom Guide/Wheel

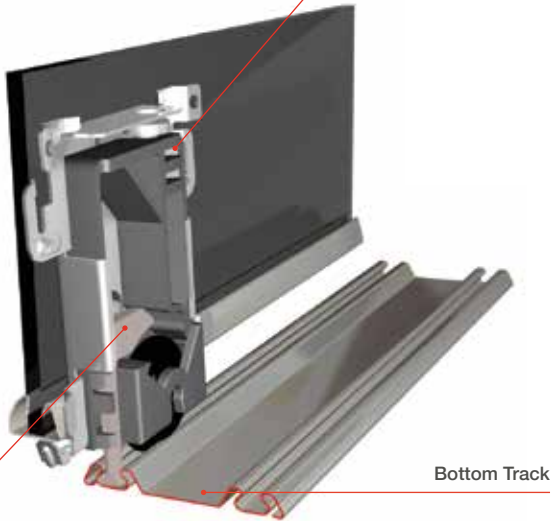

Anti-Jump Flag

Bottom Track

Top Track



Top Guide/Wheel

Door Installation Order

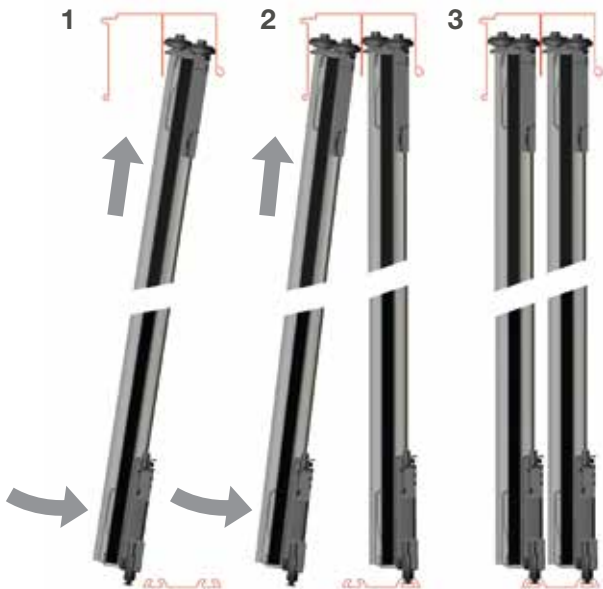

Technical Information

Calculating doors and overlap widths.

Sliding Door Overlap	75mm
Door Height	Opening height minus 54mm (track & wheel allowance)
Door Width (for sliding doors)	$\frac{\text{Opening width} + (\text{Number of overlaps} \times \text{Overlap length})}{\text{Number of doors}}$
Stile Length	Door height minus 2mm
Rails & H-Section Lengths	Finished door width minus 2 x overlap
Panel Height (1 Panel)	Door height minus 2mm
Panel Height (Multi Panel)	Panel height divided by the quantity minus 51mm for each break
Panel Width	Finished door width minus 2mm

Door configurator can be provided on request.

Ask your Spacepro account manager for information about notching tools.

Visit spaceprohardware.com for more information

SHAKER



Finishes available to Shaker Doors

- WC** Platinum White
- OK** Lancaster Oak
- NC** Cashmere
- GR** Graphite
- SG** Stone Grey
- LG** Light Grey

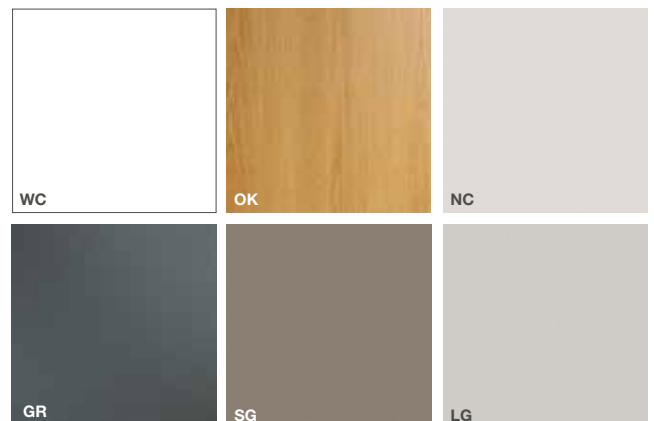

space·pro^o
HARDWARE

CLEVER STORAGE...
FOR ANY ROOM,
IN ANY HOME

SHAKER
Door Hardware

spaceprohardware.com

Home Decor GB Ltd
Innovation Way, Woodhouse Mill, Sheffield, S13 9AD. UK
+44 (0) 114 293 3000